

Article number: 20167V502SW

Description: Wide base clamp GN167-V50-2-SW
GN167

Measures

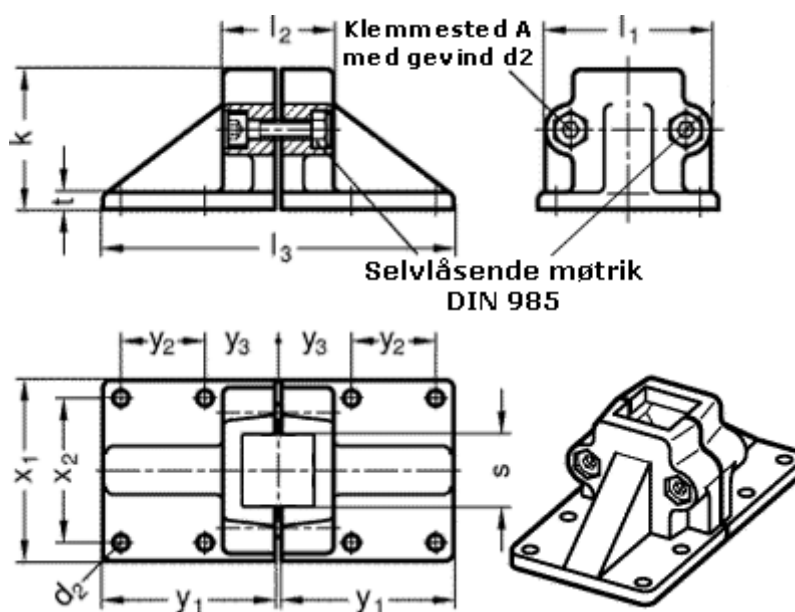

d2 = 11	x1 = 115
d3 = M10	x2 = 90
k = 91	y1 = 108
l1 = 98	y2 = 50
l2 = 70	y3 = 45
l3 = 218	
S = V50	
t = 14	